

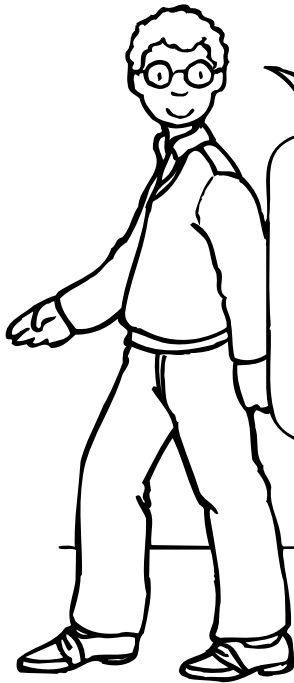

## At School

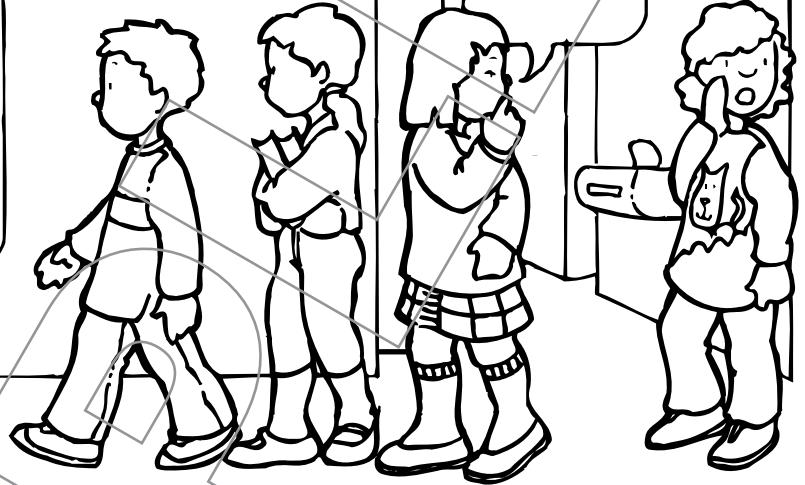

Follow me.  
Be quiet. Walk.  
Keep hands and feet to yourself.

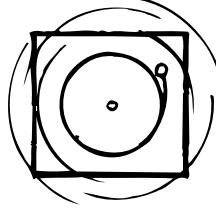

## At Home

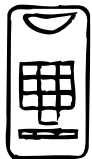

Call 911 if there  
is a fire. Get  
away from the  
house fast!

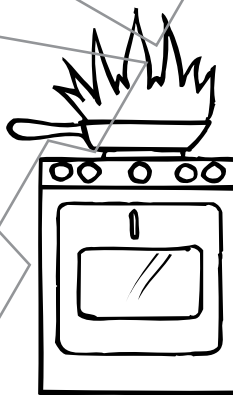



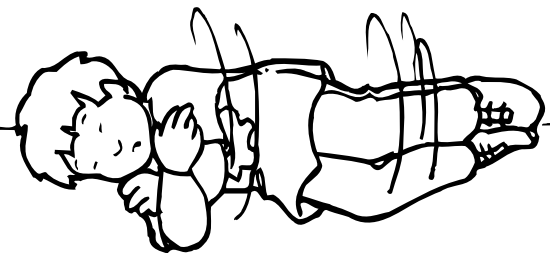

Stop, drop, and  
roll if your  
clothes catch  
on fire.





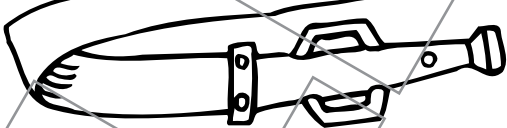

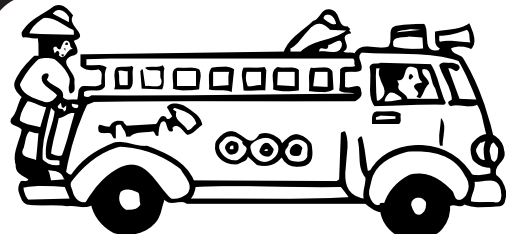
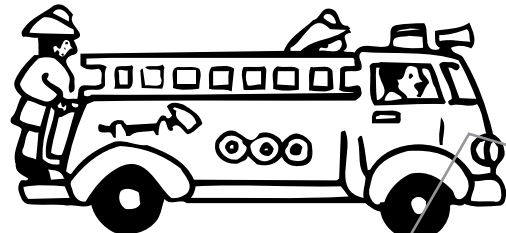
Read about fire safety with your teacher.  
Tell ways that you can stay safe.



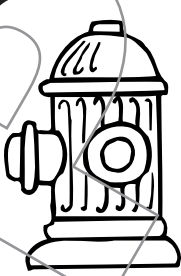
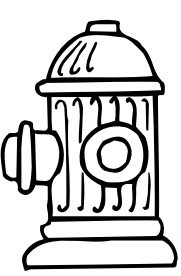
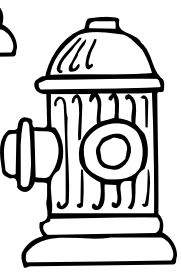

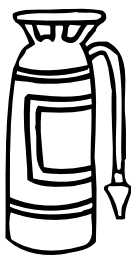

	1
	2
	3

	1
	2
	3

	1
	2
	3

	3
	4
	5
	

	3
	4
	5
	
	

Count the things in each group.  
 Circle the numeral in the box that shows how many.